

NG-LAVT

CUBICLE



▣ NG (Neutral Grounding) Cubicle

NG cubicle is used to install Neutral Grounding Transformer (NGT) and Neutral Grounding Resistor (NGR) for grounding / earthing of neutral current during unbalanced three phase load of a generator, essentially required for protection of the generator winding.

The Neutral Grounding Transformer (NGT) steps down the Neutral side voltage of the generator to 110 or 220 Volt level. This stepped down voltage is fed to a Neutral Grounding Resistor and a ground earth Terminal for bringing the voltage level of neutral bus as close as possible to zero voltage level.

Why a Neutral Grounding Resistor / Neutral Earthing Resistor ?

Neutral Grounding Resistors are used for grounding of industrial power system. They are generally connected between ground and neutral of the transformers, generators and grounding transformers. Neutral grounding resistors are used in order to limit maximum fault current to a value which will not damage the equipment in the power system, yet allow sufficient flow of fault current to operate protective relays to clear the fault. Although it is possible to limit fault currents with high resistance Neutral Grounding Resistor, earth short circuit currents can be extremely reduced. As a result of this fact, protection devices may not sense the fault. Therefore, it is the most common application to limit single phase fault currents with low resistance Neutral Grounding Resistor to approximately rated current of transformer and / or generator.

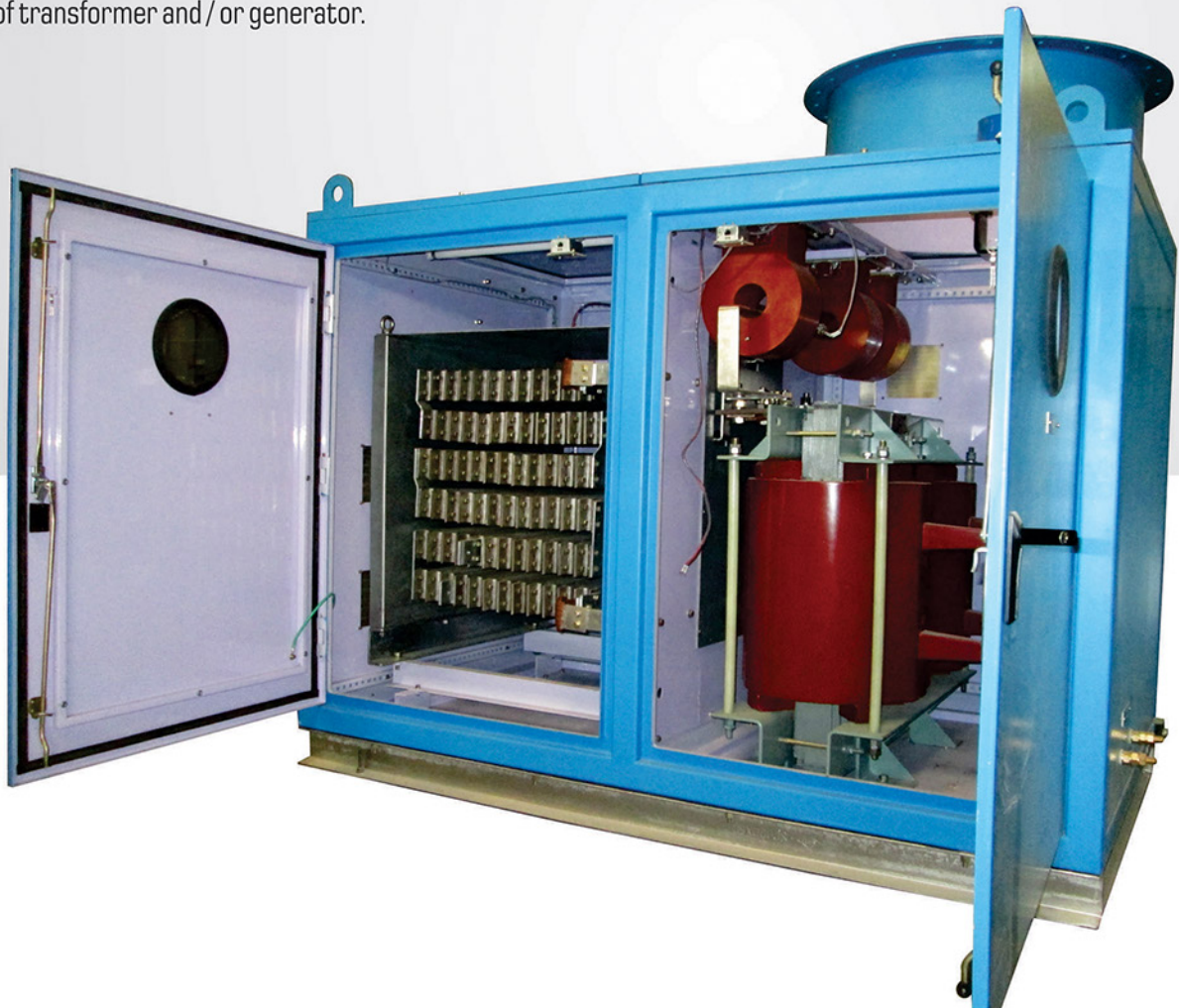

• Salient Features

1. The Enclosure / Cubicle is normally fabricated out of 2 or 3 mm thickness CRCA (MS) sheet in folded Type construction.
2. Cubicle is divided into 2 separate compartments, housing NGT in one and NGR in another.
3. Main Neutral bus bar connection is dropped down from bus duct to inside of NG cubicle through a duct, further connecting to a NGT.
4. Hinged doors in front for easy accessibility, with ergonomic 3 point locks are provided to the enclosure.
5. The cubicle is painted after suitable metal pretreatment & surface preparation.
6. Our standard color shades are RAL 7035, RAL7032, RAL 5012, IS5:631 & Other customized options are also available.
7. Louvers with wire mesh are provided in the NG compartment for proper ventilation.
8. NGR compartment offer IP 23 and NGT compartment up to IP 55 (protection class).
9. Base frame is constructed from ISMC 100.
10. Door sealing is done by PU foam / Neoprene gasket.
12. Viewing window is provided on front door.
13. Welded lifting lugs provided for higher load carrying capacity.

▣ Typical GA / Structural Design (NG Cubicle)

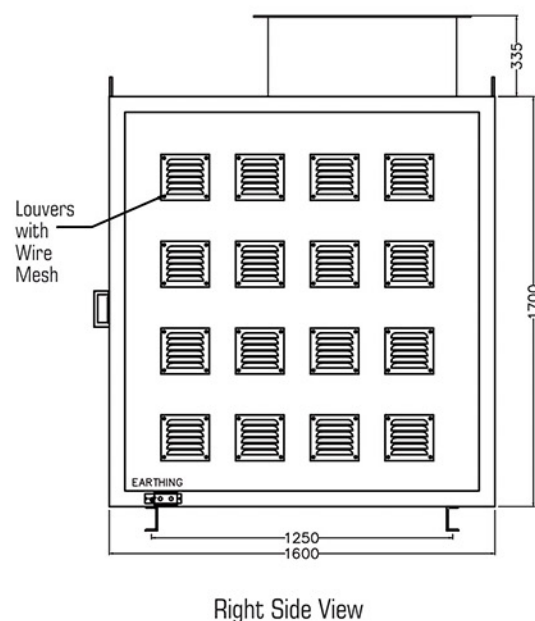
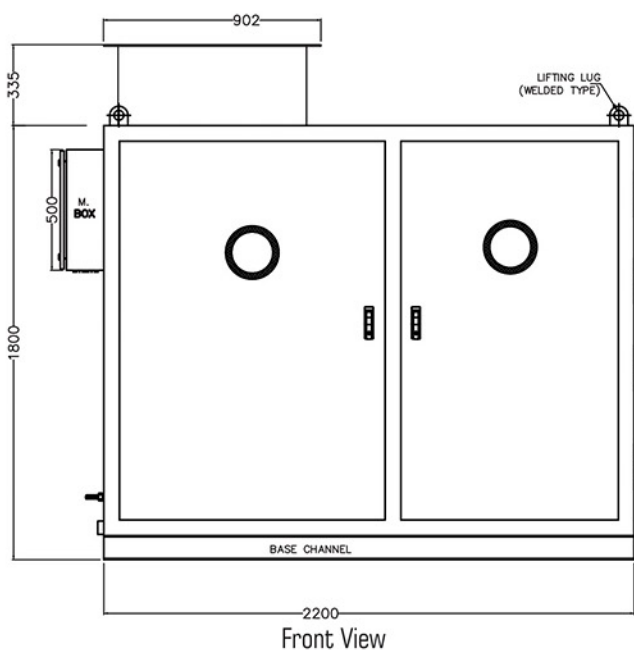
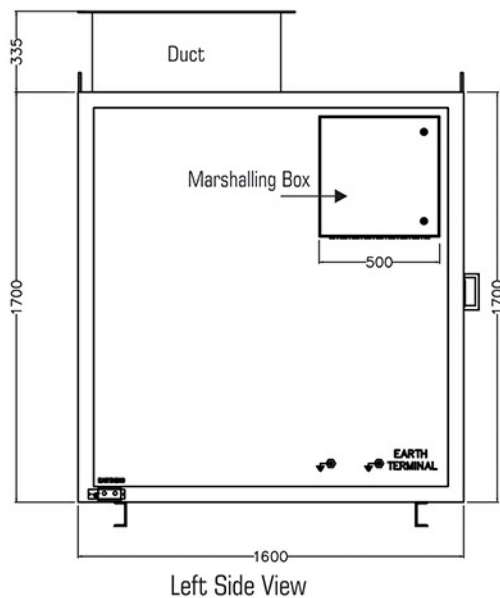

▣ LAVT / SPVT Cubicles

These LAVT cubicles are enclosure for housing the followings:

1. Lightning Arrestor (LA) / Surge Protector (SP)
2. Surge Capacitor (SC)
3. Voltage Transformers / Potential Transformers (VT/PT)

These LAVT cubicles are installed in Power generating Units for the following purpose :

- ▶ To protect the generator from High Voltage Surge during Lightning stroke or electrical fault. LA & SC provide minimum resistance path to the short duration high voltage & high current because of lightning or fault and the complete current flows to ground earth point through earthing bus bars.
- ▶ For measurement of voltage of a generating unit with the help of VT's/PT's.
 - (a) For measurement of power (Metering)
 - (b) Protection circuit
 - (c) Synchronization of the unit.

VT's of various accuracies step down the generator voltage of 6.6 KV - 15.75 KV to 110 Volt for the purpose of Metering, Protection & Synchronization.

The design of LAVT cubicle depends on :-

- (a) Voltage level of the generator.
- (b) Type of bus duct system between generator and step up transformer of the power plant.

Depending upon above mentioned factors LAVT cubicles are designed as :

- (a) IPB (Isolated Phase Bus Duct) - The three cubicles for R,Y,B phase are separated with air gap of 200 to 1300 mm.
- (b) SPB (Segregated Phase Bus Duct) - The three cubicle to R,Y,B phase are put together side by side.



▣ Equipment in LAVT Cubicles

Lightning Arrestor is to provide protection against any surges in voltage. It is a device that safely diverts any surge in voltage to the earth, therefore protecting the equipment against surges.

A **Surges Capacitor** is connected in parallel with the Lightning Arrestor for enhanced protection.

The **Voltage Transformer** is provided for protection /metering to feed meters like Voltmeter, Wattmeter or Protection Relays etc. VT transforms the high primary voltage, to a low voltage of 110V to give an accurate representation of the system volts, which can be incorporated into protection devices and measuring devices. LAVT Panels are used in all Power Plants for protection of the Generator. This unit is phase isolated and is mostly connected to the bus duct.



• Salient Features

1. The Enclosure / Cubicle is normally fabricated out of 2 or 3mm thickness CRCA (MS) sheet in folded Type construction.
2. Enclosure design are modular, fully compartment type cabinet system.
3. Light weight and sturdy with standardized trolley .
4. Easy and flexible trolley - in and out arrangement .
5. Hinged doors with supporting levers in front for easy accessibility, and maintenance purpose .
6. The cubicle is painted after suitable metal pretreatment & surface preparation .
7. Our standard color shade are RAL 7035, RAL7032, RAL5012, IES 631 & Other customized option are also provided.
8. LAVT compartment offer IP 55 protection class.
9. Base frame is constructed from ISMC 100.
10. Door sealing is done by PU foam / Neoprene gasket.
11. Viewing window is provided on front door.
12. Locking arrangement is done with cam type single point IP lock.
13. Welded lifting lugs provided for higher load carrying capacity .

Typical GA / Structural Design (LAVT Cubicle)

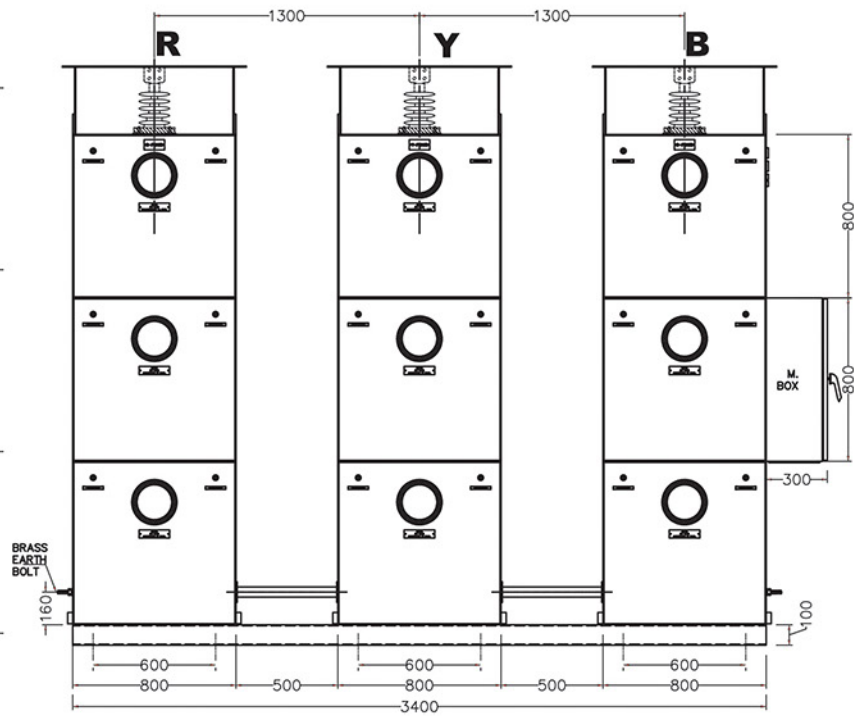

Front View

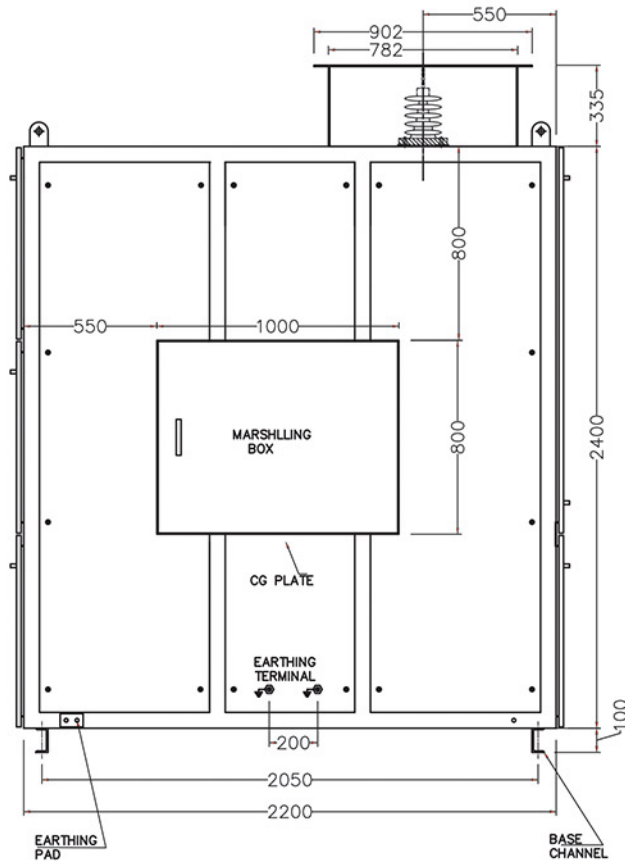

Right Hand Side (RHS) View

Internal View & Arrangements

NG Cubicle :

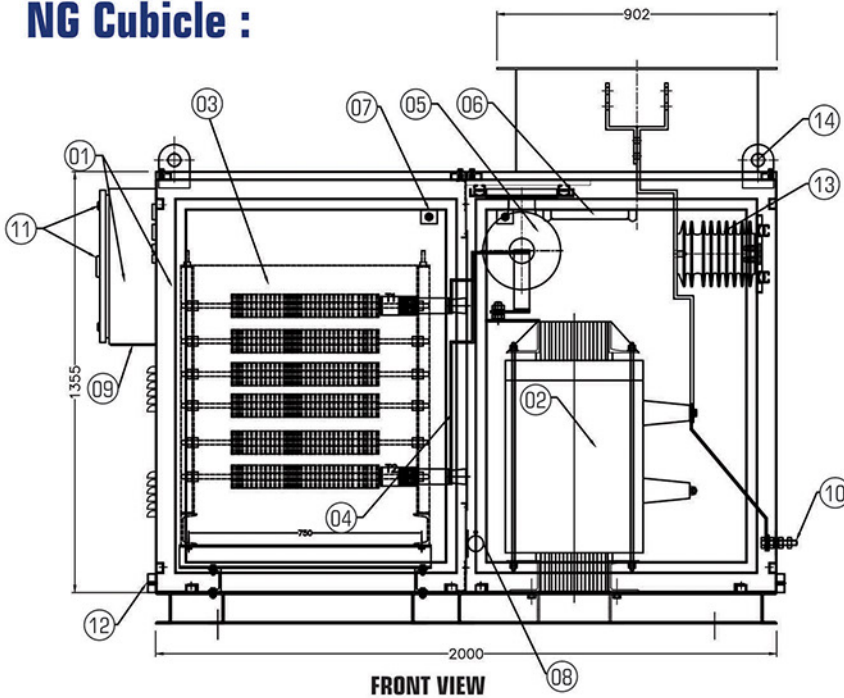

- 01 NG Cubicle with Marshalling Box
- 02 Neutral Grounding Transformer
- 03 Neutral Grounding Resistor
- 04 Fibre Glass Insulation Sheet
- 05 Current Transformer
- 06 Fluorescent Lamp 240V, 20 W
- 07 Door Switch
- 08 Space Heater with Thermostat
- 09 Cable Gland Plate for Marshalling Box
- 10 Equipment Earthing Terminal
- 11 IP Lock & Handle
- 12 MS Earthing Pad (Body Earthing)
- 13 HT Support Insulator
- 14 Lifting Lugs

LAVT Cubicle :

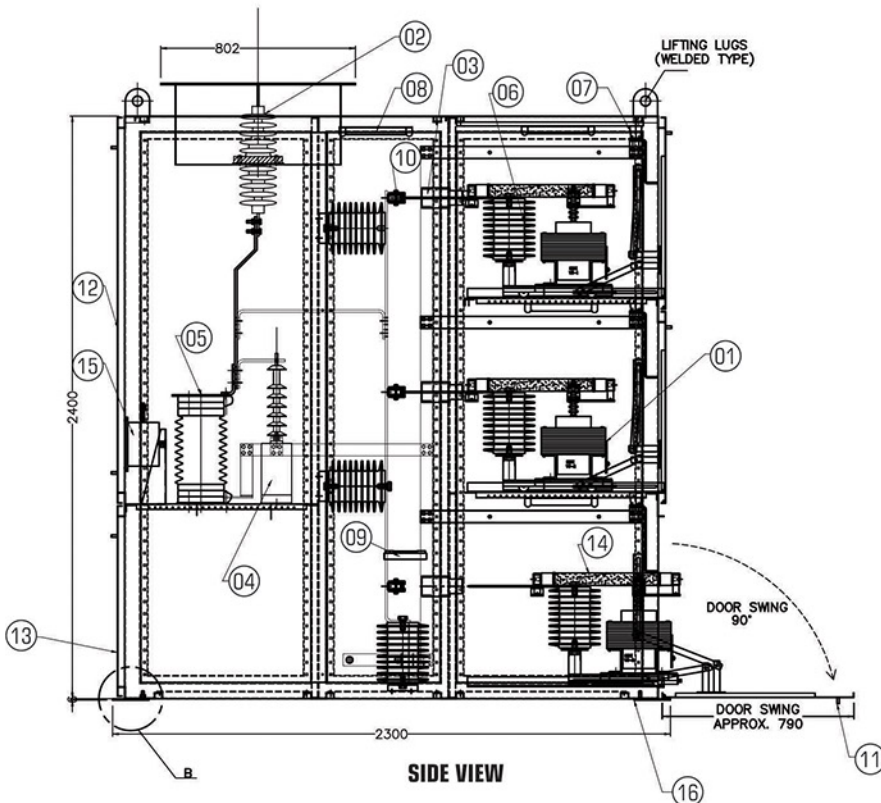

- 01 Cast Resin Voltage Transformer (VT-1,2,&3)
- 02 Epoxy Roof Bushing
- 03 Automatic Shutter
- 04 Surge Capacitor
- 05 Lightning Arrester
- 06 HT Support Insulator
- 07 Epoxy LT Support Insulator
- 08 Fluorescent Lamp
- 09 Space Heater with Built-in Thermostat
- 10 Fixed Contact
- 11 Hingeable Door for VT Compartment
- 12 Removable Bolted Cover for LA, SC Compartment
- 13 Removable Bolted Cover for Rear spare compartment
- 14 H.T. Fuse
- 15 Surge Counter
- 16 Base MS Plate / Base Channel

Our Other Products Range



- Shelter • Mosaic Desk • Console Desk • Bare Panel IP-65 • PLC Panel • Mosaic Mimic Panel • Local Control Station
- FRP Box • LIE - LIR • Power Distribution Box • Purge & Ex-proof • Acrylic Mimic • NG / LAVT Cubicle • Generator Control Panel
- MCC / PCC / IMCC • CT Box • APFC Panel • Bus Duct (NSPD) • Soft Starter Panel • Synchronization Panel • HT Panel
- Videowalls • Networking Panel • Bare Panel IP-55 • Junction Box • Control & Relay Panels • Alcosy Control Desk
- Metering Panel • Metering Box • Marshalling Panels • EMI/RFI Compliant Panel • Universal Test Bench • Push Button Station
- 19" Racks • Control Room Interiors

Clients who believes in us....



HEAD OFFICE AND FACTORY:

E-329, Road No.12, Mewar Industrial Area, Udaipur-313003 Rajasthan, India
 Ph:+91-294-2492122/31/34
 Mobile : +91-9352500364
 Fax:+91-294-2492130
 E-mail: pyrotech@pyrotechindia.com
 marketing@pyrotechindia.com

NOIDA OFFICE:

C-140, Sector 63, Nodia-201301 (Uttar Pradesh)
 Mobile : +91-88004 88792
 E-mail: pmpppl@pyrotechindia.com
 electricals@pyrotechindia.com

BANGALORE OFFICE:

Pyrotech Electronics Pvt. Ltd.
 (Southern Regional Office)
 No. 22, 13th Main, NHCS Layout Vijaynagar, Bangalore - 560 040
 Ph.:+91-80-23509680
 Fax:+91-80-23509680
 E-mail: bangalore@pyrotechindia.com

OTHER OFFICES:

Ahmedabad	093761 26045
Bangalore	093428 16887
Bhopal	094250 16016
Hyderabad	093913 57063
Kolkata	093391 99881
Mumbai	093226 76597
Chennai	093641 87225



An ISO 9001, EMS 14001, OHSAS 18001 Company

PYROTECH ELECTRONICS PVT. LTD. UNIT-II

Mewar Industrial Area, Madri, Udaipur-313003, Rajasthan, India

Pyrotech Electronics Pvt. Ltd was established in 1976 at Udaipur, Rajasthan having more than 38 years experience in Turnkey control room interiors, Mosaic Panels & Desks, Control Panels & Desks, other Industrial Panels, Junction Boxes & Racks and more than 10 years experience of Supply, Installation & Commissioning in video wall market. We have our reach to the Power, Energy G/D/T, Oil & Gas, Metal, Transport, Defense & Cement industries etc..